



Radar Systems Engineering

Lecture 10 Part 1

Radar Clutter

Dr. Robert M. O'Donnell
IEEE New Hampshire Section
Guest Lecturer

IEEE New Hampshire Section



Block Diagram of Radar System

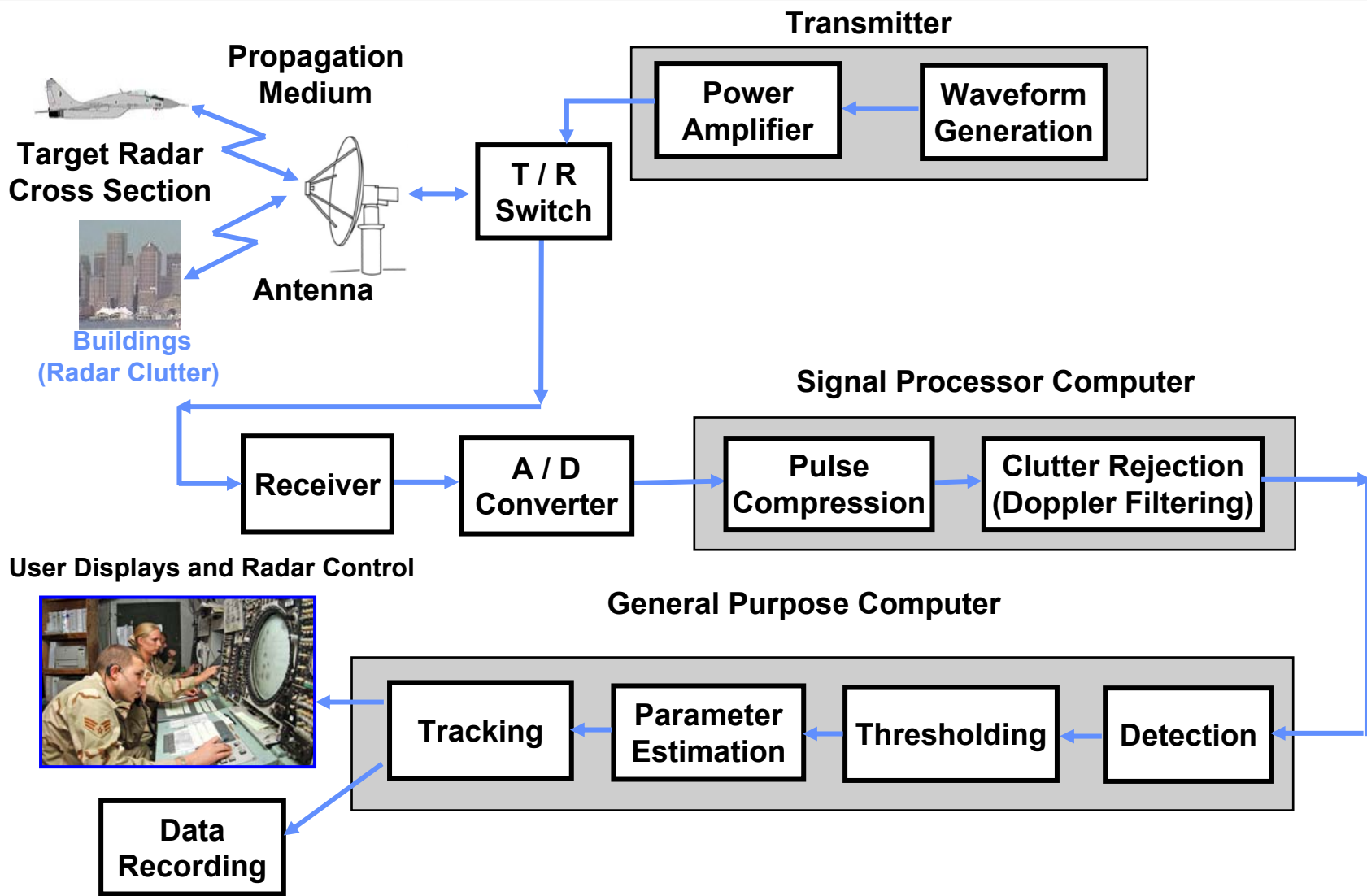
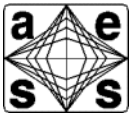

Photo Image
Courtesy of US Air Force
Used with permission.



Outline



- **Motivation**
- **Backscatter from unwanted objects**
 - **Ground**
 - **Sea**
 - **Rain**
 - **Birds and Insects**



Why Study Radar Clutter?



Naval Air Defense Scenario

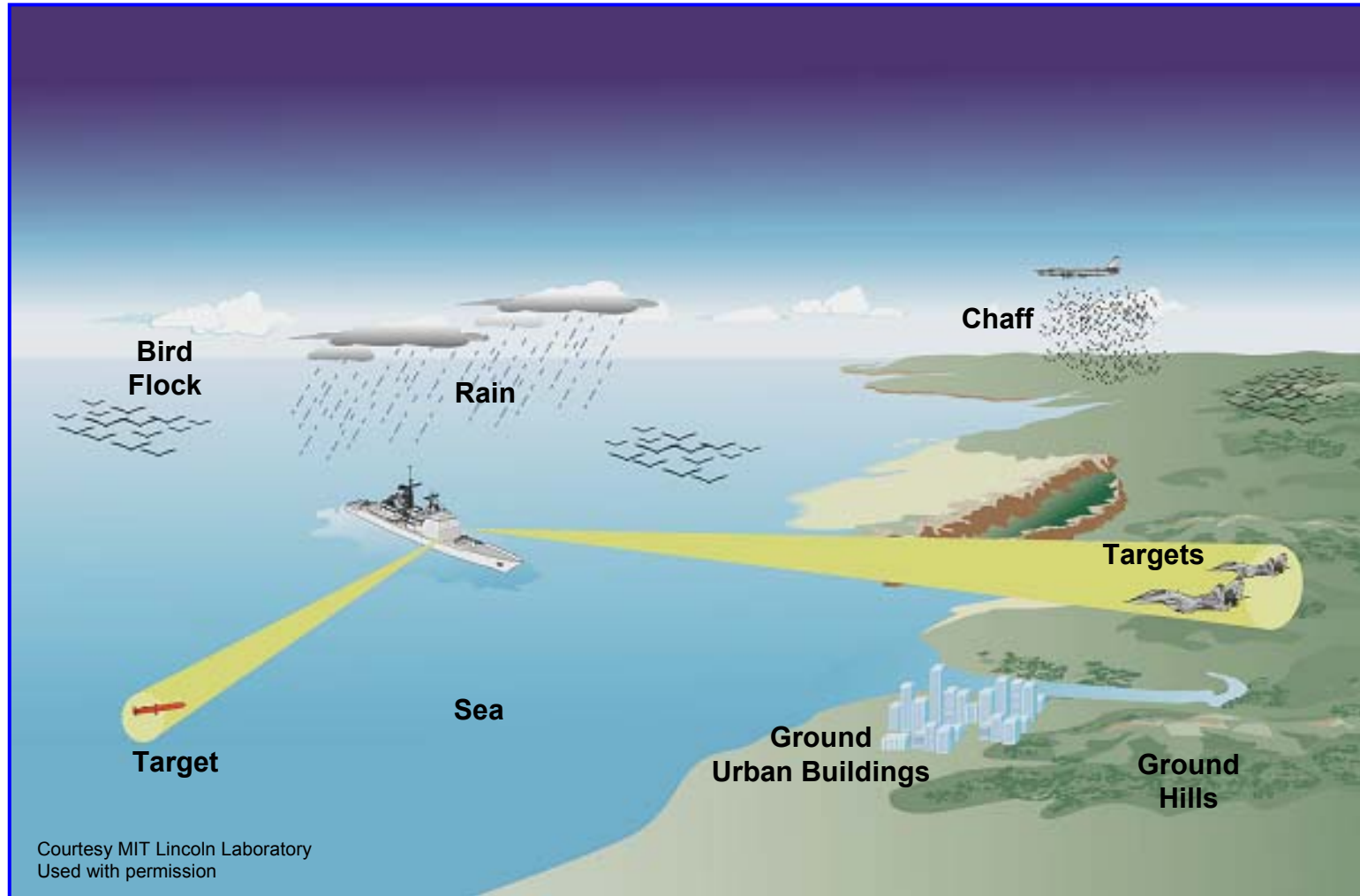



Radars for Which Clutter is a Issue

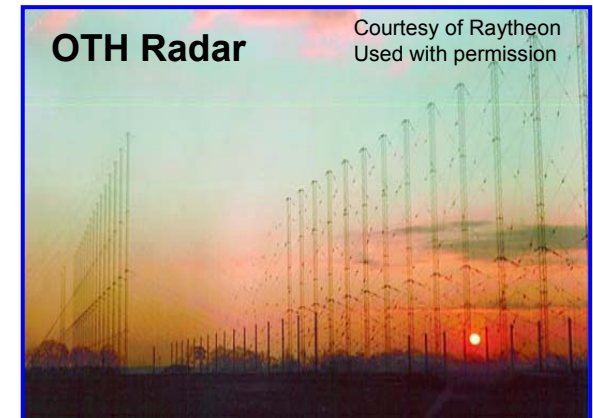
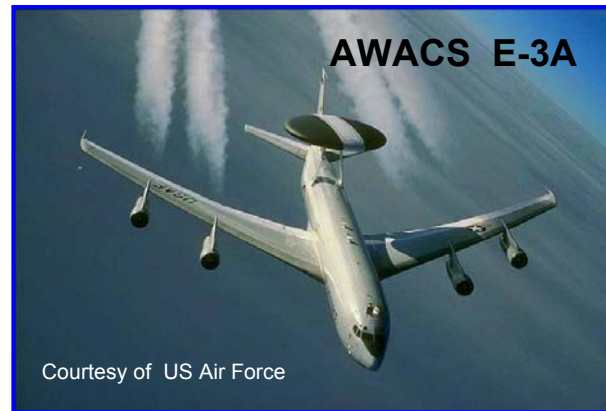
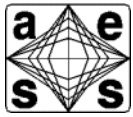



Radars for Which Clutter is a Issue





How to Handle Noise and Clutter





How to Handle Noise and Clutter

If he doesn't take his arm off my shoulder I'm going to hide his stash of Hershey Bars !!



Why does Steve always talk me into doing ridiculous stunts like this ?



Typical Air Surveillance Radar

(Used for Sample Calculations)

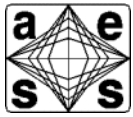

FAA - Airport Surveillance Radar



Courtesy of MIT Lincoln Laboratory
Used with permission

Radar Parameters

Frequency	S-band (2700–2900 MHz)
Instrumented range	60 nautical miles
Peak power	1.4 mw
Average power	875 W
Pulse repetition frequency	(700–1200 Hz) 1040 Hz average
Antenna rotation rate	12.8 rpm
Antenna size	4.8 m × 2.7 m
Antenna gain	33 dB



Outline



- **Motivation**
- **Backscatter from unwanted objects**



- **Ground**
- **Sea**
- **Rain**
- **Birds and Insects**



Outline - Ground Clutter



- **Introduction**
- **Mean backscatter**
 - Frequency
 - Terrain type
 - Polarization
- **Temporal statistics**
- **Doppler spectra**



Attributes of Ground Clutter



- **Mean value of backscatter from ground clutter**
 - **Very large size relative to aircraft**
 - **Varies statistically**
 - Frequency, spatial resolution, geometry, terrain type
- **Doppler characteristics of ground clutter return**
 - **Innate Doppler spread small (few knots)**
 - Mechanical scanning antennas add spread to clutter
 - **Relative motion of radar platform affects Doppler of ground clutter**
 - Ship
 - Aircraft



Ground Based Radar Displays

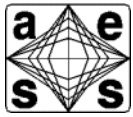

Mountainous Region of
Lakehead, Ontario, Canada
PPI Set for 30 nmi.

Plan Position Indicator (PPI) Display

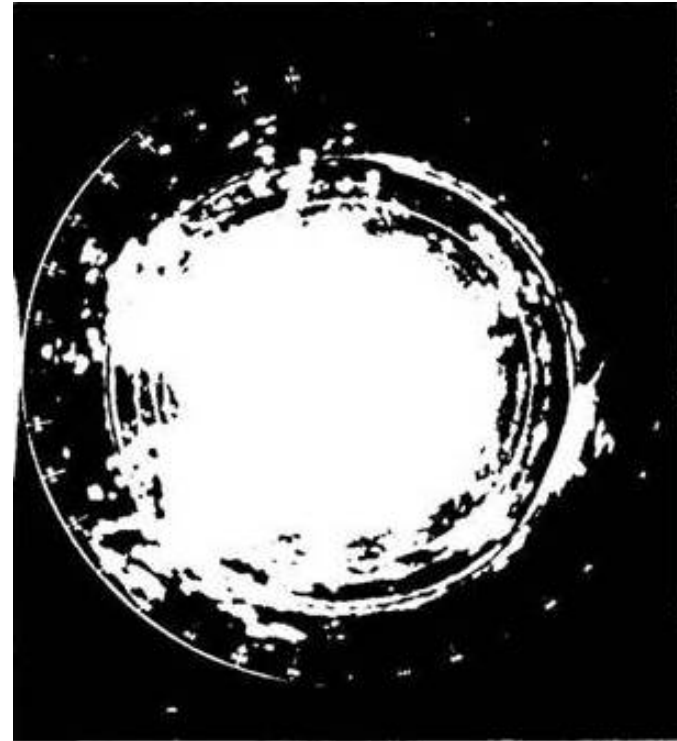

Map-like Display

Radial distance to center

Angle of radius vector

Threshold crossings

Range

Azimuth

Detections

0 dB

Shrader, W. from Tutorial on MTI Radar presented at Selenia, Rome, Italy.
Used with permission.



Photographs of Ground Based Radar's PPI (Different Levels of Attenuation)

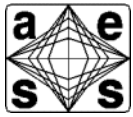

Mountainous Region of
Lakehead, Ontario, Canada
PPI Set for 30 nmi.

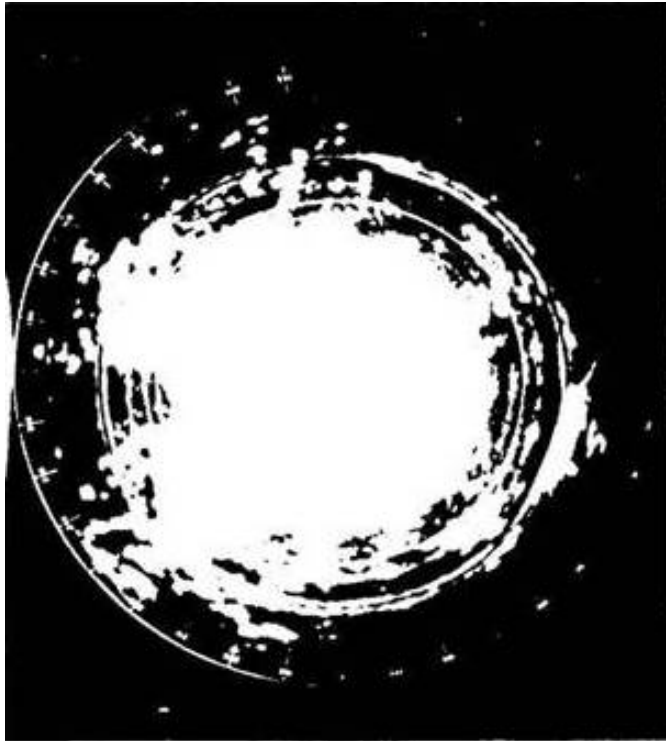

Attenuation Level 0 dB



Attenuation Level 60 dB

Shrader, W. from Tutorial on MTI Radar presented at Selenia, Rome, Italy.
Used with permission.



Photographs of Ground Based Radar's PPI



Different Levels of Attenuation

0 dB

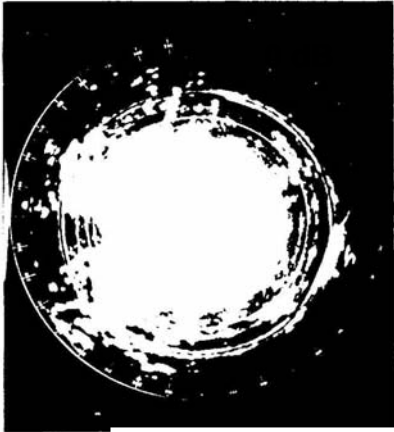

10 dB

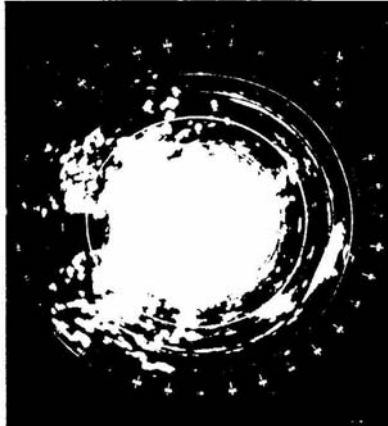

40 dB



50 dB

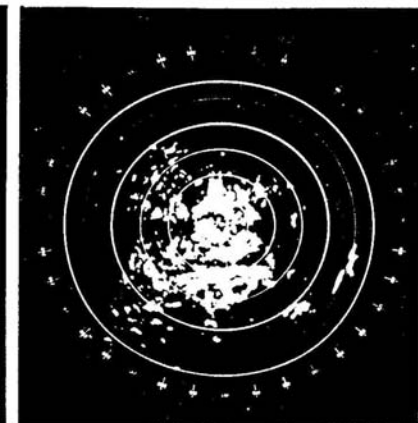

20 dB

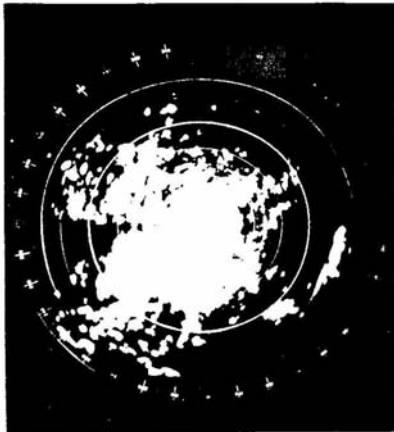

30 dB

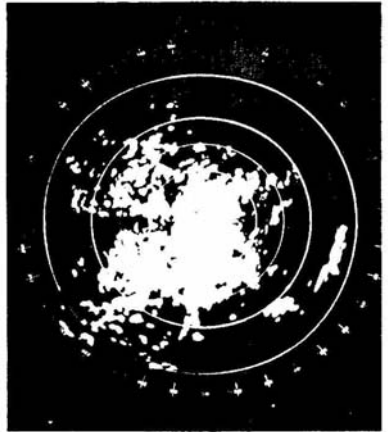

60 dB



70 dB

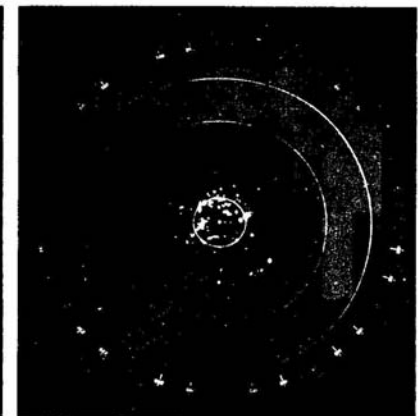

Shrader, W. from Tutorial on MTI Radar presented at Selenia, Rome, Italy.
Used with permission.



Geometry of Radar Clutter



Elevation View

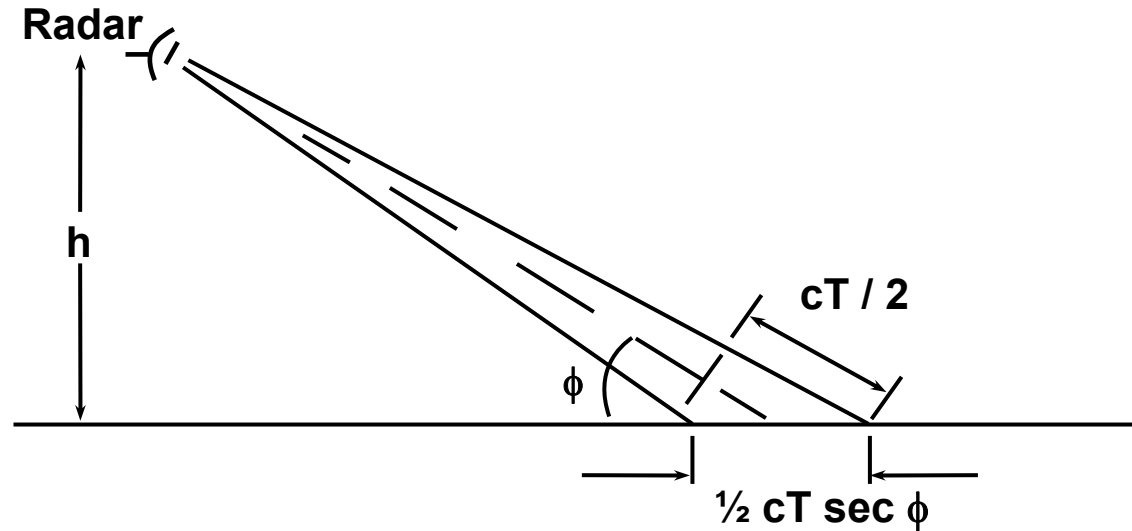

Plan View

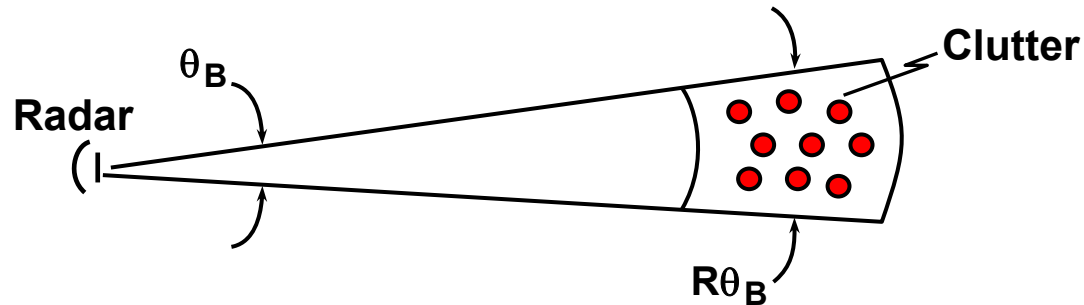

$$\sigma_0 = \frac{\sigma}{A}$$

$$A = R\theta_B [\frac{1}{2} cT \sec \phi]$$

Courtesy of MIT Lincoln Laboratory
Used with permission



Calculation of Ground Clutter



- Typical Value of $\sigma_o = -20 \text{ dB} = \frac{0.01 \text{ m}^2}{\text{m}^2}$

- $\sigma_{\text{Clutter}} = \sigma_o A = \sigma_o \frac{c T}{2} R \theta_B$

– For ASR-9 (Airport Surveillance Radar)

$$\frac{c T}{2} = 100 \text{ m} \quad R = 60 \text{ km} \quad \theta_B = 1.5^\circ = 0.026 \text{ radians}$$

- $\sigma_{\text{Clutter}} = \frac{0.01 \text{ m}^2}{\text{m}^2} \times 100 \text{ m} \times 60,000 \text{ m} \times 0.026 \text{ radians} = 1500 \text{ m}^2$

For $\sigma_{\text{Target}} = 1 \text{ m}^2$

Small
single-engine
aircraft

INPUT

$$\frac{\sigma_{\text{Target}}}{\sigma_{\text{Clutter}}} = \frac{1}{1500}$$

OUTPUT

$$\frac{\sigma_{\text{Target}}}{\sigma_{\text{Clutter}}} = 20$$

**\therefore Must suppress clutter by a factor of
 $1500 \times 20 = 30,000 = 45 \text{ dB}$**

For good
detection

Courtesy of MIT Lincoln Laboratory
Used with permission

IEEE New Hampshire Section
IEEE AES Society



Joint U.S./Canada Measurement Program

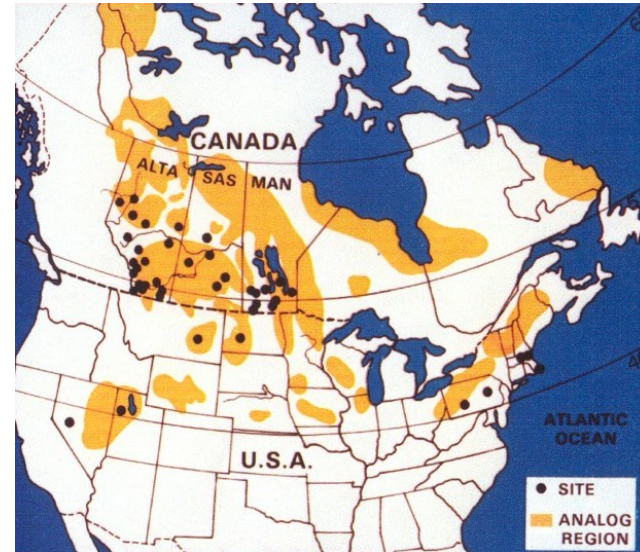
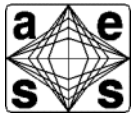

- **Phase One radar**
 - VHF, UHF, L-, S-, X-bands
- **Measurements conducted 1982 – 1984**
- **Archival data at Lincoln Laboratory**

- **42 sites**
- **Data shared with Canada and the United Kingdom**

Courtesy of MIT Lincoln Laboratory
Used with permission

IEEE New Hampshire Section
IEEE AES Society



Joint U.S./Canada Measurement Program



Phase One Radar



Courtesy of MIT Lincoln Laboratory

Radar System Parameters

Frequency Band (MHz)	VHF	UHF	L-Band	S-Band	X-Band
Antenna Gain (dB)	13	25	28.5	35.5	38.5
Antenna Beamwidth					
Az (deg)	13	5	3	1	1
Ei (deg)	42	15	10	4	4
Peak Power (kW)	10	10	10	10	10
Polarization	HH,VV	HH,VV	HH,VV	HH,VV	HH,VV
PRF (Hz)	500	500	500	500	500
Pulse Width (μ s)	0.1, 0.25, and 1	0.1, 0.25, and 1	0.1, 0.25, and 1	0.1, 0.25, and 1	0.1, 0.25, and 1
Waveform	Uncoded CW Pulse	Uncoded CW Pulse	Uncoded CW Pulse	Uncoded CW Pulse	Uncoded CW Pulse
A/D Converter					
Number of Bits	13	13	13	13	13
Sampling Rate (MHz)	10, 5, 1	10, 5, 1	10, 5, 1	10, 5, 1	10, 5, 1

Adapted from Billingsley, Reference 2



Clutter Physics

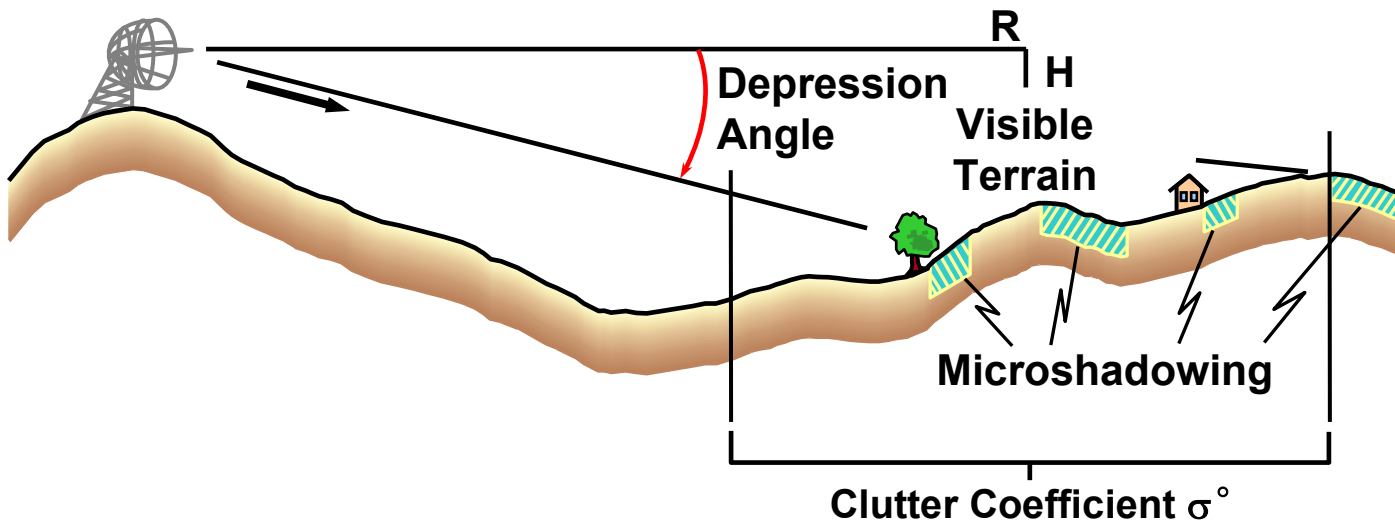

Courtesy of MIT Lincoln Laboratory
Used with permission



Histograms of Measured Clutter Strength $\sigma^{\circ}F^4$ (dB)

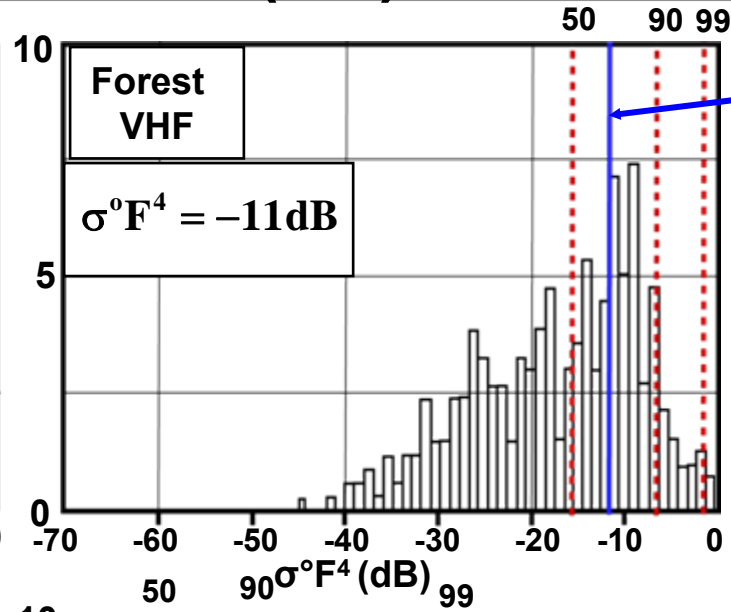
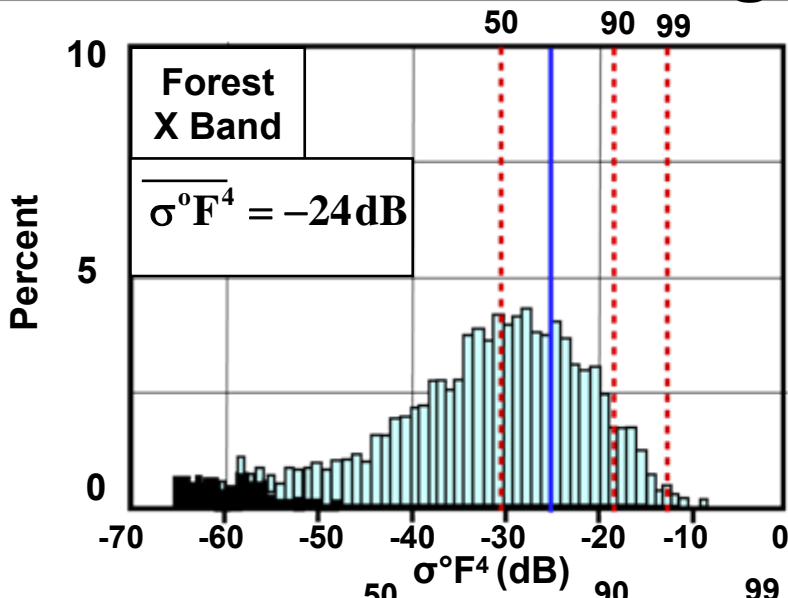

Blue Line Is Mean

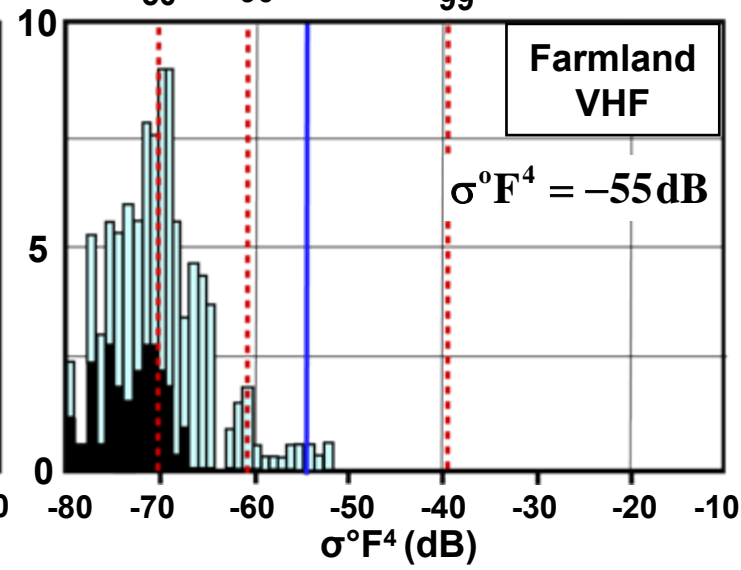
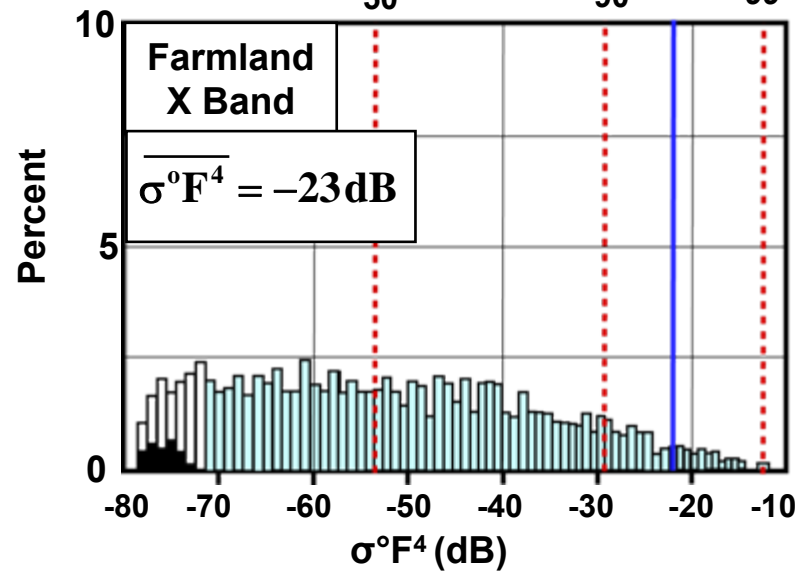



Clutter Physics

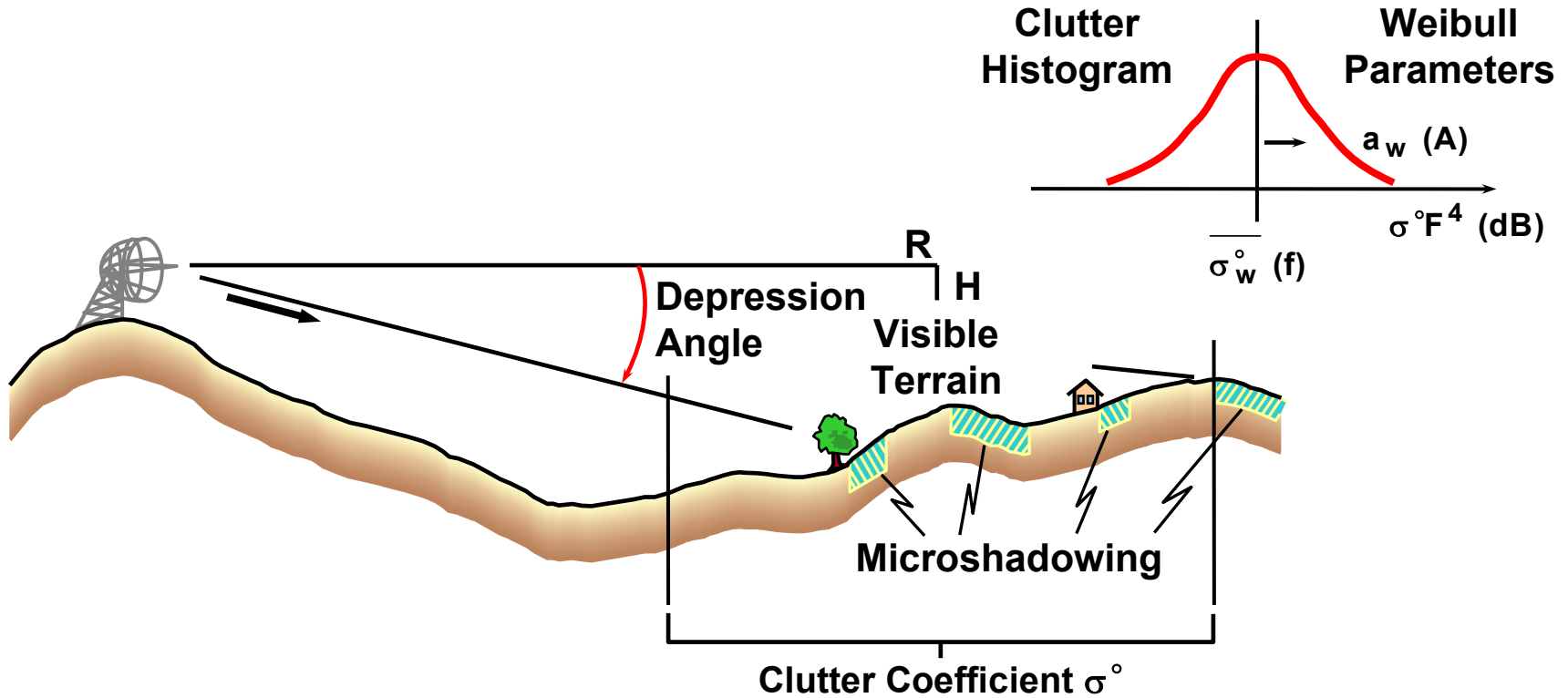
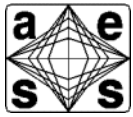

Courtesy of MIT Lincoln Laboratory
Used with permission

IEEE New Hampshire Section
IEEE AES Society



Weibull Probability Density Function



$$p(\mathbf{x}) = \frac{b \cdot (\log_2 2) \cdot \mathbf{x}^{b-1}}{\mathbf{x}_{50}^b} \cdot e^{-\frac{\log_2 \mathbf{x}^b}{\mathbf{x}_{50}^b}}$$

\mathbf{x}_{50} = Median value of \mathbf{x}

$b = 1 / a_w$

a_w = Weibull shape parameter

$\mathbf{x} = \sigma^0 F^4$ In units of m^2/m^2

- The Weibull and Log Normal distributions are used to model ground clutter, because they are two parameter distributions which will allow for skewness (long tails) in the distribution of ground clutter
- For $a_w = 1$, the Weibull distribution degenerates to an Exponential distribution in power (a Rayleigh distribution in voltage)



Clutter Physics

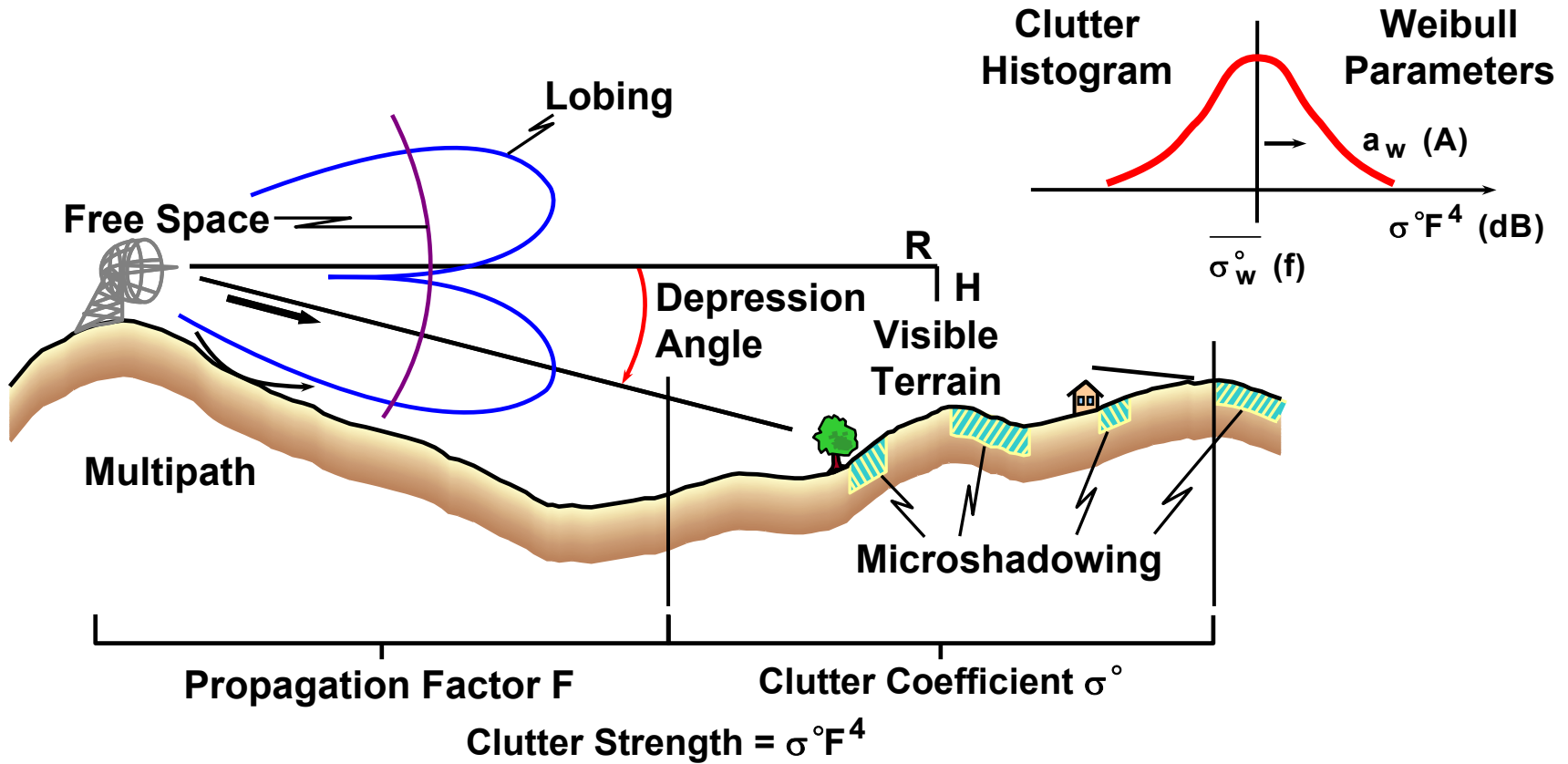

Courtesy of MIT Lincoln Laboratory
Used with permission

IEEE New Hampshire Section
IEEE AES Society



Clutter Physics

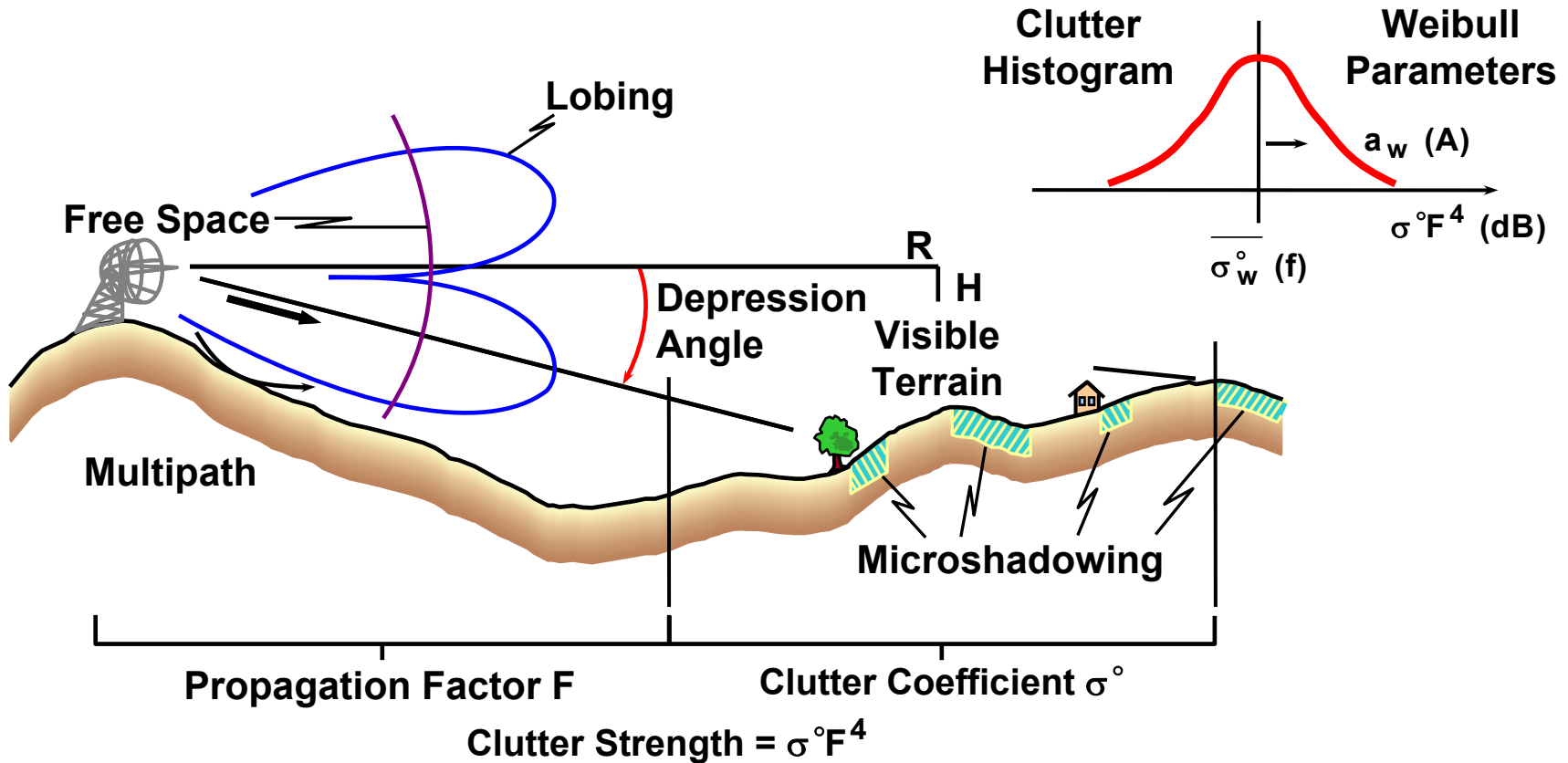
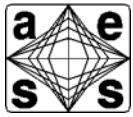

1) Radar Parameters

- Frequency, f
- Spatial resolution, A

2) Geometry

- Depression angle
(Range R , Height H)

3) Terrain Type

- Landform
- Land cover

Courtesy of MIT Lincoln Laboratory Used with permission



Mean Ground Clutter Strength vs. Frequency

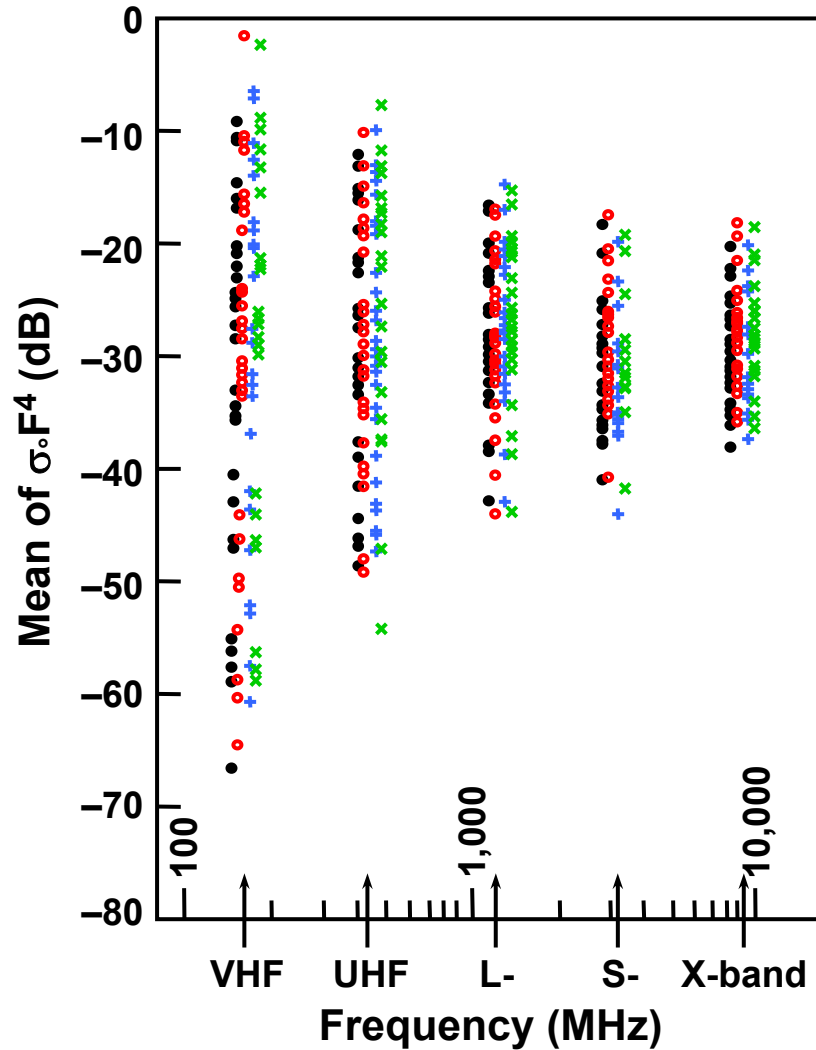

General Rural (36 Sites)

Key

Range	Resolution (m)	Polarization
150	150	H •
150	150	V ◦
15/36	15/36	H +
15/36	15/36	V ×

Courtesy of MIT Lincoln Laboratory
Used with permission

IEEE New Hampshire Section
IEEE AES Society



Major Clutter Variables in Data Collection



- **Terrain type**
 - Forest
 - Urban
 - Farmland
 - Mountains
 - Farmland
 - Desert, marsh, or grassland (few discrete scatterers)
- **Terrain slope:**
 - High ($>2^\circ$)
 - Low ($<2^\circ$)
 - Moderately low (1° to 2°)
 - Very low ($<1^\circ$)
- **Depression angle**
 - High 1° to 2°
 - Intermediate 0.3° to 1°
 - Low $<0.3^\circ$



Land Clutter Backscatter vs. Terrain Type and Frequency



Terrain Type	Median Value of $\sigma^{\circ}F$ (dB)				
	Frequency Band				
	VHF	UHF	L-Band	S-Band	X-Band
URBAN	-20.9	-16.0	-12.6	-10.1	-10.8
MOUNTAINS	-7.6	-10.6	-17.5	-21.4	-21.6
FOREST/HIGH RELIEF (Terrain Slopes $> 2^{\circ}$)					
High Depression Angle ($> 1^{\circ}$)	-10.5	-16.1	-18.2	-23.6	-19.9
Low Depression Angle ($\leq 0.2^{\circ}$)	-19.5	-16.8	-22.6	-24.6	-25.0
FOREST/LOW RELIEF (Terrain Slopes $< 2^{\circ}$)					
High Depression Angle ($> 1^{\circ}$)	-14.2	-15.7	-20.8	-29.3	-26.5
Intermediate Depression Angle (0. 4° to 1°)	-26.2	-29.2	-28.6	-32.1	-29.7
Low Depression Angle ($\leq 0.3^{\circ}$)	-43.6	-44.1	-41.4	-38.9	-35.4
AGRICULTURAL/HIGH RELIEF (Terrain Slopes $\geq 2^{\circ}$)	-32.4	-27.3	-26.9	-34.8	-28.8
AGRICULTURAL/LOW RELIEF					
Moderately Low Relief ($1^{\circ} <$ Terrain Slopes $< 2^{\circ}$)	-27.5	-30.9	-28.1	-32.5	-28.4
Moderately Low Relief (Terrain Slopes $< 1^{\circ}$)	-56.0	-41.1	-31.6	-30.9	-31.5
DESERT, MARSH, GRASSLAND (Few Discrettes)					
High Depression Angle ($\geq 1^{\circ}$)	-38.2	-39.4	-39.6	-37.9	-25.6
Low Depression Angle ($\leq 0.3^{\circ}$)	-66.8	-74.0	-68.6	-54.4	-42.0

Adapted from Billingsley, Reference 2



Statistical Attributes of X-Band Ground Clutter

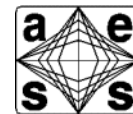

Terrain Type	Depressi on Angle (deg)	Weibull Parameters			Mean Clutter Strength (dB)	Percent of Samples Above Radar Noise Floor	Number Of Patches
		a_w	σ_{50}^o	σ_w^o			
Rural Low- Relief	0.00-0.25	4.8	-60	-33	-32.0	36	413
	0.25-0.50	4.1	-53	-32	-30.7	46	448
	0.50-0.75	3.7	-50	-32	-29.9	55	223
	0.75-1.00	3.4	-46	-31	-28.5	62	128
	1.00-1.25	3.2	-44	-30	-28.5	66	92
	1.25-1.50	2.8	-40	-29	-27.0	69	48
	1.50-4.00	2.2	-34	-27	-25.6	75	75
Rural/ High-Relief	0-1	2.7	-39	-28	-26.7	58	176
	1-2	2.4	-35	-26	-25.9	61	107
	2-3	2.2	-32	-25	-24.1	70	44
	3-4	1.9	-29	-23	-23.3	66	31
	4-5	1.7	-26	-21	-22.2	74	16
	5-6	1.4	-25	-21	-21.5	78	9
	6-8	1.3	-22	-19	-19.1	86	8
Urban	0.00-0.25	5.6	-54	-20	-18.7	57	25
	0.25-0.70	4.3	-42	-19	-17.0	69	31
	0.70-4.00	3.3	-37	-22	-24.0	73	53

Adapted from Billingsley, Reference 2



Weibull Parameters for Ground Clutter Distributions

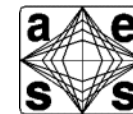

Terrain Type	Depression Angle (deg)	$\sigma_w^o (dB)$					a_w	
		Frequency Bands					Resolution(m ²)	
		VHF	UHF	L-Band	S-Band	X-Band	10 ³	10 ⁶
Rural/Low Relief								
a) General Rural	0.0 to 0.25	-33	-33	-33	-33	-33	3.8	2.5
	0.25 to 0.75	-32	-32	-32	-32	-32	3.5	2.2
	0.75 to 1.50	-30	-30	-30	-30	-30	3.0	1.8
	1.50 to 4.00	-27	-27	-27	-27	-27	2.7	1.6
	> 4.00	-25	-25	-25	-25	-25	2.6	1.5
b) Forest	0.00 to 0.30	-45	-42	-40	-39	-37	3.2	1.8
	0.30 to 1.00	-30	-30	-30	-30	-30	2.7	1.6
	> 1.00	-15	-19	-22	-24	-26	2.0	1.3
c) Farmland	0.00 to 0.40	-51	-39	-30	-30	-30	5.4	2.8
	0.40 to 0.75	-30	-30	-30	-30	-30	4.0	2.6
	0.75 to 1.50	-30	-30	-30	-30	-30	3.3	2.4
d) Desert, marsh, or grassland (few discrettes)	0.00 to 0.25	-68	-74	-68	-51	-42	3.8	1.8
	0.25 to 0.75	-56	-58	-46	-41	-36	2.7	1.6
	> 0.75	-38	-4	-40	-38	-26	2.0	1.3
Rural/High Relief								
a) Rural	0 to 2	-27	-27	-27	-27	-27	2.2	1.4
	2 to 4	-24	-24	-24	-24	-24	1.8	1.3
	4 to 6	-21	-21	-21	-21	-21	1.6	1.2
	>6	-19	-19	-19	-19	-19	1.5	1.1
Forest	Any	-15	-19	-22	-22	-22	1.8	1.3
Mountains	Any	-8	-11	-18	-20	-20	2.8	1.6
Urban								
a) General urban	0.0 to 0.25	-20	-20	-20	-20	-20	4.3	2.8
	0.25 to 0.75	-20	-20	-20	-20	-20	3.7	2.4
	>0.75	-20	-20	-20	-20	-20	3.0	2.0
b) Urban, observed on open terrain)	0.00 to 0.25	-32	-24	-15	-10	-10	4.3	2.8
Neg. Depression Angle								
a) All except mountains & forest	0.0 to 0.25	-31	-31	-31	-31	-31	3.4	2.0
	0.25 to 0.75	-27	-27	-27	-27	-27	3.3	1.9
	>0.75	-26	-26	-26	-26	-26	2.3	1.7

Adapted from Billingsley, Reference 2



L-Band Clutter Experiment Radar

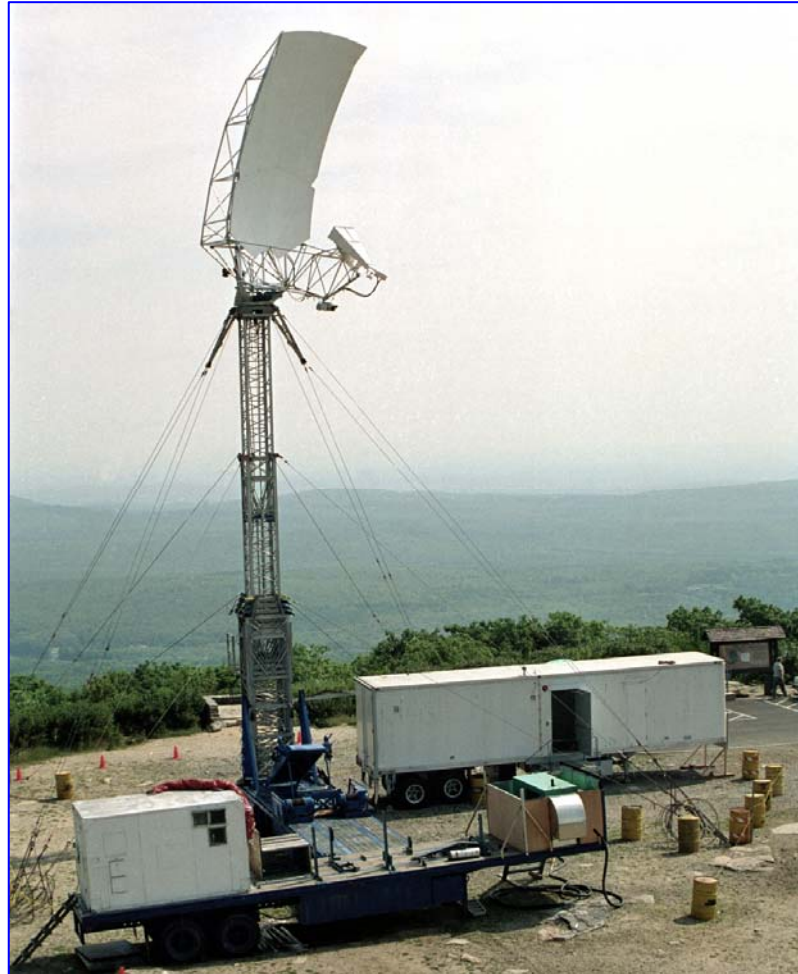
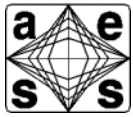

Courtesy of MIT Lincoln Laboratory
Used with permission

Radar System Parameters

Frequency Band (MHz)	L-Band (1230)
Antenna Gain (dB)	32
Antenna Beamwidth	
Az (deg)	6
EI (deg)	3
Peak Power (kW)	8
Polarization	HH, VV, HV, VH
PRF (Hz)	500
Pulse Width (μs)	1
Waveform	Uncoded CW Pulse
A/D Converter	
Number of Bits	14
Sampling Rate (MHz)	2



Windblown Clutter Spectral Model



- Total spectral power density $P_{tot}(\nu)$ from a cell containing windblown vegetation

Ratio of DC power to AC power

DC spectral power density

AC spectral power density

$$P_{tot}(\nu) = \frac{r}{r+1} \delta(\nu) + \frac{1}{r+1} P_{ac}(\nu)$$

Doppler velocity in m/s

Exponential shape parameter

$$P_{ac}(\nu) = \frac{\beta}{2} \exp(-\beta|\nu|)$$

North Dakota Cropland (Wheat)
Measured Data

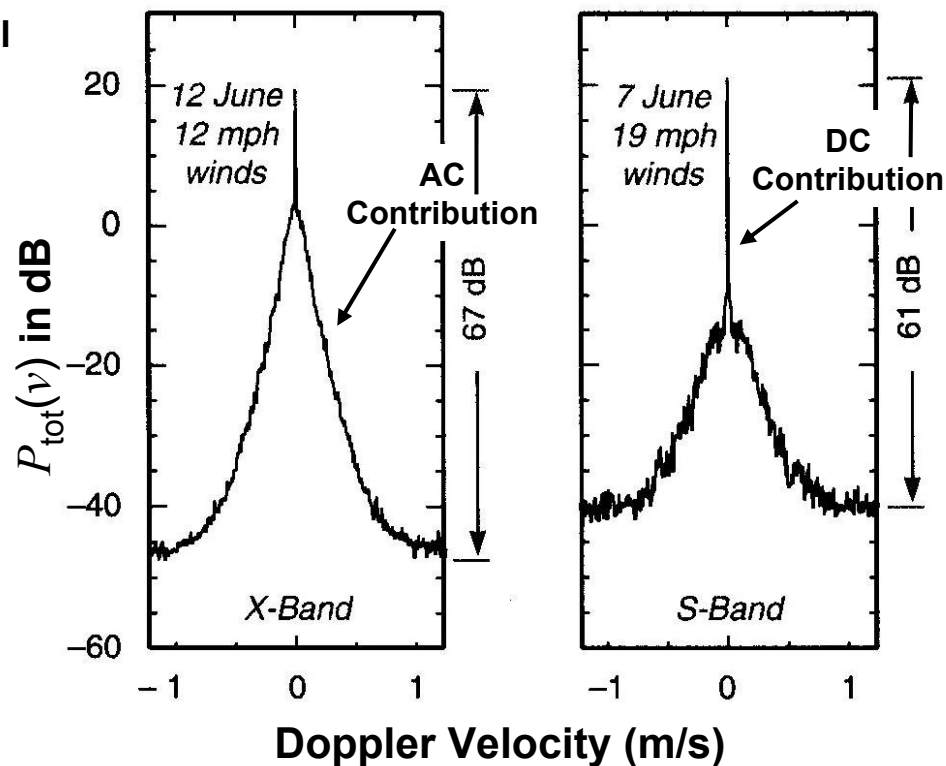

Adapted from Billingsley, Reference 2



Measured Power Spectra of L-Band Radar Returns from Forest

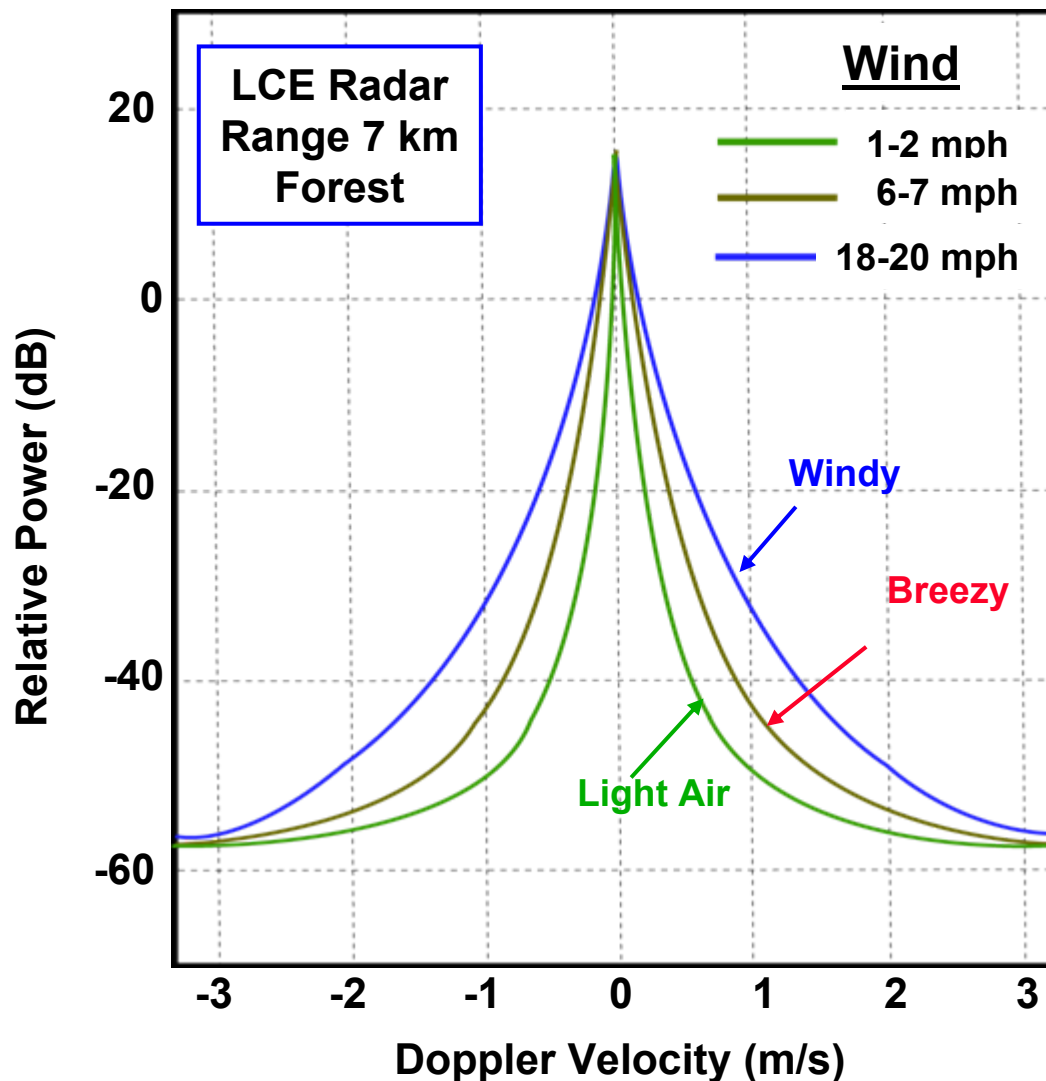

Curves are hand drawn lines through data in Billingsley Reference 2

Adapted from Billingsley, Reference 2



Modeled Rates of Exponential Decay in the Tails of L-Band Spectra from Wind-Blown Trees

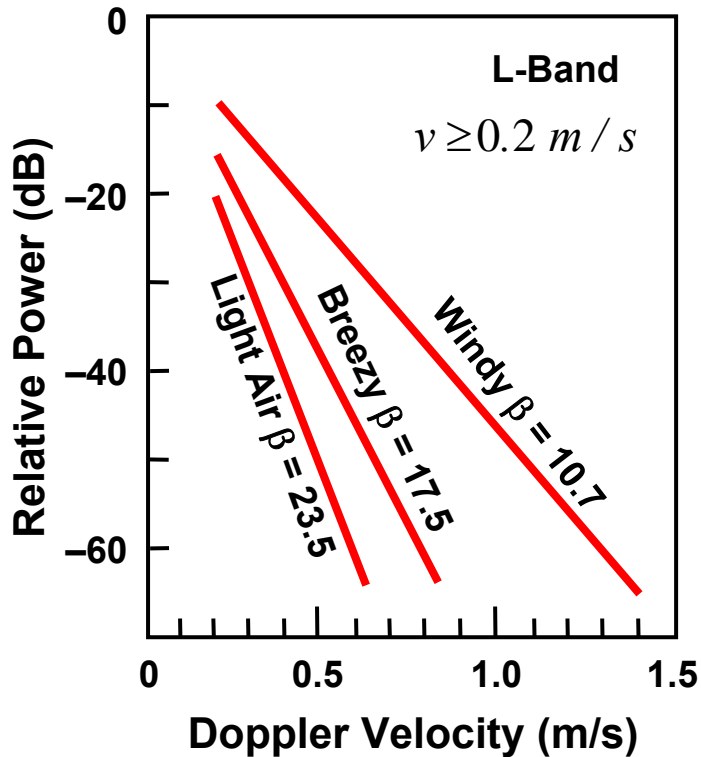
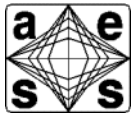

- Exponential decay model agrees very well with measured data
 - X-Band to L-band
 - Variety of wind conditions
Light thru heavy wind
 - Over wide dynamic range
> 50 dB
- Previously used Gaussian and power law models break down at wide dynamic ranges
- Model parameter β empirically developed from measured data

$$P_{ac}(v) = \frac{\beta}{2} \exp(-\beta |v|)$$

Exponential shape parameter

$$\beta^{-1} = 0.105 [\log_{10} w + 0.4147]$$

Velocity of wind
(statute miles per hour)

Adapted from
Billingsley, Reference 2



Estimated Ground Clutter at Medium Depression Angles (~3 to 70°)

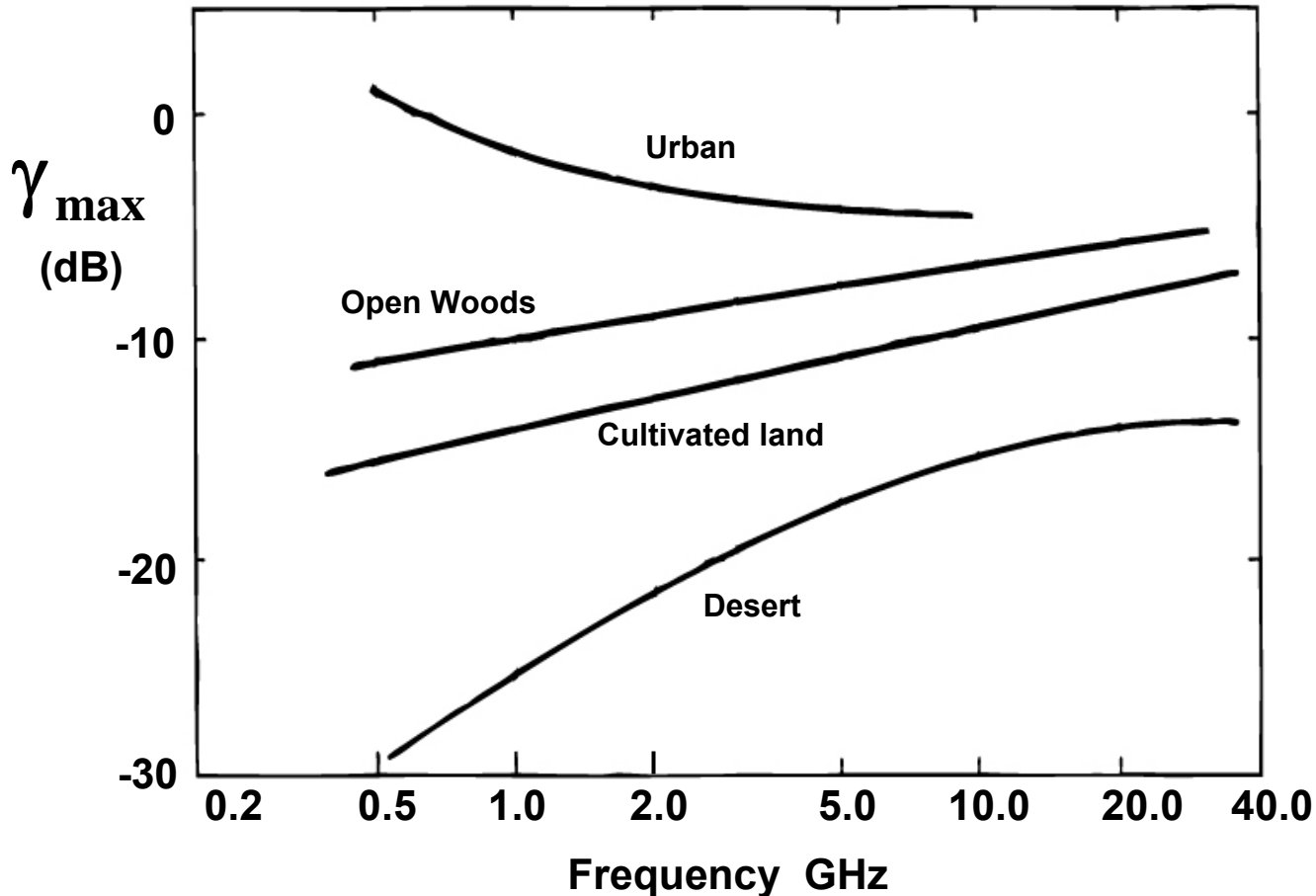

$$\gamma = \frac{\sigma^0}{\sin \psi}$$

ψ = Grazing Angle

σ^0 = Backscatter Coefficient

Many data collections indicate that from ~3 to ~70 degrees σ^0 is proportional to $\sin \psi$ (Ref 6)

Curves are Skolnik's estimates from Nathanson data (see Reference 6)



High Depression Angle Ground Clutter

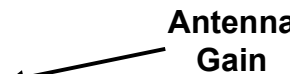

- σ_0 can be large near vertical incidence
- In this angle regime the reflected energy is due to backscatter from small flat surfaces on the ground
- The total backscatter is the sum of contributions from the different depression angles within the antenna's beam width
 - For vertical incidence, σ_0 measured is $< \sigma_0$ at exactly 90°
- For an ideal smooth reflecting surface, $\sigma_0 \approx G$ 
 - This is a better approximation for smooth sea than typically more rough land (lower for land)
 - σ_0 generally > 1 and $>$ than resolution cell size)
(see Reference 6)



Ground Clutter Spectrum Spread Due to Mechanical Scanning of Antenna



- Backscatter from ground modulated by varying gain of antenna pattern as beam scans by ground clutter
- Ground clutters Doppler spread: $1.3^\circ = 0.023$ radians

$$\sigma_{\text{clutter}} = \frac{\Omega}{3.78 \theta_B}$$

$\Omega =$ Antenna rotation rate (Hz)

$\theta_B =$ Antenna beamwidth (radians)

$$\sigma_{\text{clutter}} = \frac{0.265}{n T}$$

$n =$ Number of pulses in 3 dB antenna beamwidth

$T =$ Time between radar pulses (sec)

- For FAA Airport Surveillance Radar (S-Band, $\lambda = 10$ cm):

$$\Omega = 12.7 \text{ RPM, } 76.2^\circ/\text{sec} \quad n = 22$$

$$\theta_B = 1.3^\circ$$

$$T = 0.8 \text{ msec.}$$

$$\sigma_c \approx 15 \text{ Hz}$$



Outline



- **Motivation**
- **Backscatter from unwanted objects**
 - **Ground**
 - – **Sea**
 - **Rain**
 - **Birds and Insects**



Attributes of Sea Clutter



- **Mean cross section of sea clutter depends on many variables**

- Radar frequency
- Wind and weather
- Sea State
- Grazing angle
- Radar Polarization
- Range resolution
- Cross range resolution

- **Sea clutter is characterized by**
 - Radar cross section per unit area σ^0

Sea Clutter → $\sigma = \sigma^0 \Lambda$ ← Area Illuminated by Radar Beam

Radar Cross Section

Mean sea backscatter is about 100 times less than ground backscatter

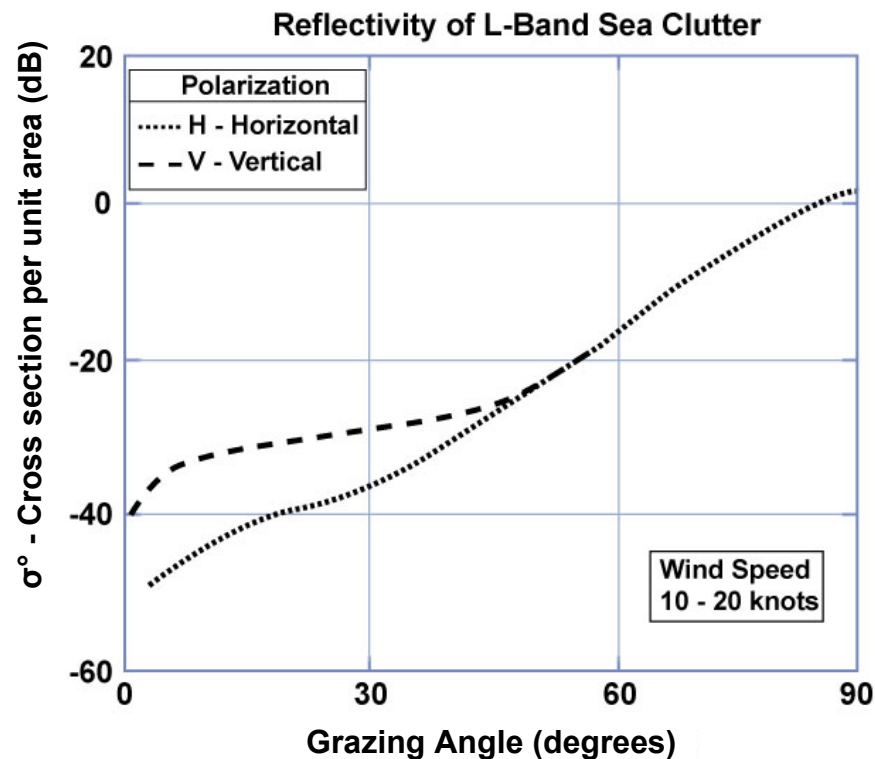
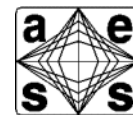

Figure by MIT OCW.



World Meteorological Organization Sea State Classification



<u>Sea State</u>	<u>Wave Height (m)</u>	<u>Wind Velocity (knots)</u>	<u>Descriptive Term</u>
0 to 1	0 to 0.1	0 to 6	Calm, Rippled
2	0.1 to 0.5	7 to 10	Smooth, Wavelets
3	0.6 to 1.2	11 to 16	Slight to Moderate
4	1.2 to 2.4	17 to 21	Moderate to Rough
5	2.4 to 4	22 to 27	Very Rough
6	4 to 6	28 to 47	High

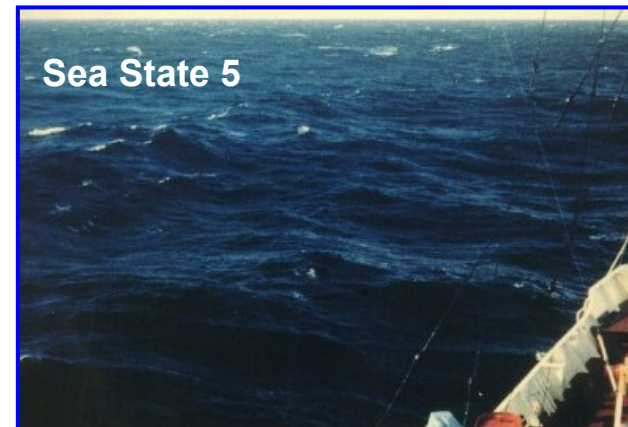

Courtesy of NOAA



Sea Clutter



- **Environmental parameters**
 - **Wave height**
 - **Wind speed**
 - **The length of time and distance (Fetch) over which the wind has been blowing**
 - **Direction of the waves relative to the radar beam**
 - **Whether the sea is building up or decreasing**
 - **The presence of swell as well as sea waves**
 - **The presence of contaminants that might affect the surface tension**
- **Radar parameters**
 - **Frequency**
 - **Polarization**
 - **Grazing angle**
 - **Range and cross range resolution**
- **The data has “A curse of dimensionality”**
 - **The sea backscatter depends on a large number of variables**

Adapted from Nathanson, Reference 3



Nathanson Data Compilation of Mean Backscatter Data



- **Models compiled from experimental data**
 - Upwind, downwind, and crosswind data averaged over
 - Adjusted from incidence/depression angle to grazing angle
 - Median values adjusted to mean values
 - Monostatic radar data; 0.5–5.9 μs pulse; Rayleigh distributions
- **Original data set (1968), 25 references**
- **Present data set (1991), about 60 references**
- **Grazing angles: -0.1° , 0.3° , 1.0° , 3.0° , 10.0° , 30.0° , 60.0°**

Adapted from Nathanson, Reference 3



Normalized Mean Sea Backscatter Coefficient σ_0 (dB below 1 m²/m²)



Grazing Angle = 1°

<u>Sea State</u>	<u>Polarization</u>	<u>UHF</u> <u>0.5 GHz</u>	<u>L</u> <u>1.25</u>	<u>S</u> <u>3.0</u>	<u>C</u> <u>5.6</u>	<u>X</u> <u>9.3</u>	<u>Ku</u> <u>17</u>	<u>Ka/W</u> <u>35/95</u>
0	V		68*			60*	60*	60*
	H	86*	80*	75*	70*	60*	60*	60*
1	V	70*	65*	56	53	50	50	48*
	H	84*	73*	66	56	51	48	48*
2	V	63*	58*	53	47	44	42	40*
	H	82*	65*	55	48	46	41	38*
3	V	58*	54*	48	43	39	37	34
	H	73*	60*	48	43	40	37	36
4	V	58*	45	42	39	37	35	32
	H	63*	56*	45	39	36	34	34*
5	V		43	38	35	33	34	31
	H	60*	50*	42	36	34	34	
6	V			33		31*	32	
	H			41		32*	32	

* 5-dB error not unlikely

Adapted from Nathanson, Reference 3

Data Collections and Analyses by NRL underscore this note (See Reference 2, page 15-10)



Sea Clutter Reflectivity vs. Grazing Angle

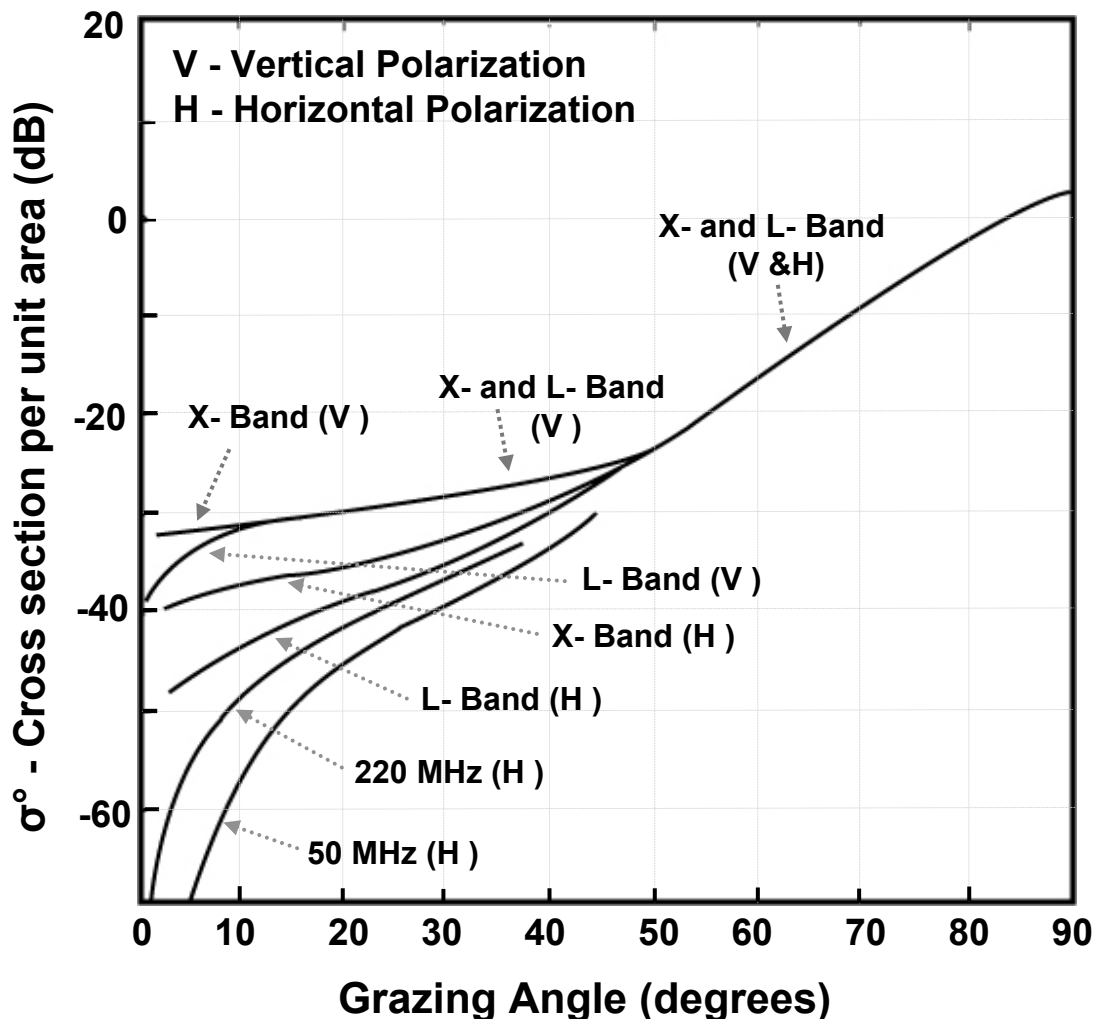

- Sea Clutter is independent of polarization and frequency for grazing angles greater than $\sim 45^\circ$
- In general, backscatter from the sea is less using horizontal polarization than vertical polarization
- For low grazing angles and horizontal polarization, the sea clutter backscatter increases as the wavelength is increased

Adapted from Skolnik, Reference 6



Amplitude Distributions



- **The distributions for sea echo are between Rayleigh and log normal**
 - **Log of sea backscatter is normally distributed**
- **Generally, sea echo for HH polarization deviates from Rayleigh more than it does for VV polarization**
- **For a cell dimension less than about 50 m, sea waves are resolved; the echo is clearly non-Rayleigh**
- **The distributions depend on sea state. The echo usually becomes more Rayleigh-like for the higher seas.**
- **For small cells and small grazing angles, sea clutter is approximately log normal for horizontal polarization**

Adapted from Skolnik, Reference 6



More attributes of Sea Clutter



- ➔ • **Sea clutter has a mean Doppler velocity and spread**
 - **Velocity of waves relative to radar (ship)**
 - Wind speed and direction
 - **Sea state**

- **Sea “spikes”**
 - **Low grazing angles**
 - **Short radar pulse widths**



Effect of Wind Speed on Sea Clutter



(Various Grazing Angles, Polarizations, and Frequencies)

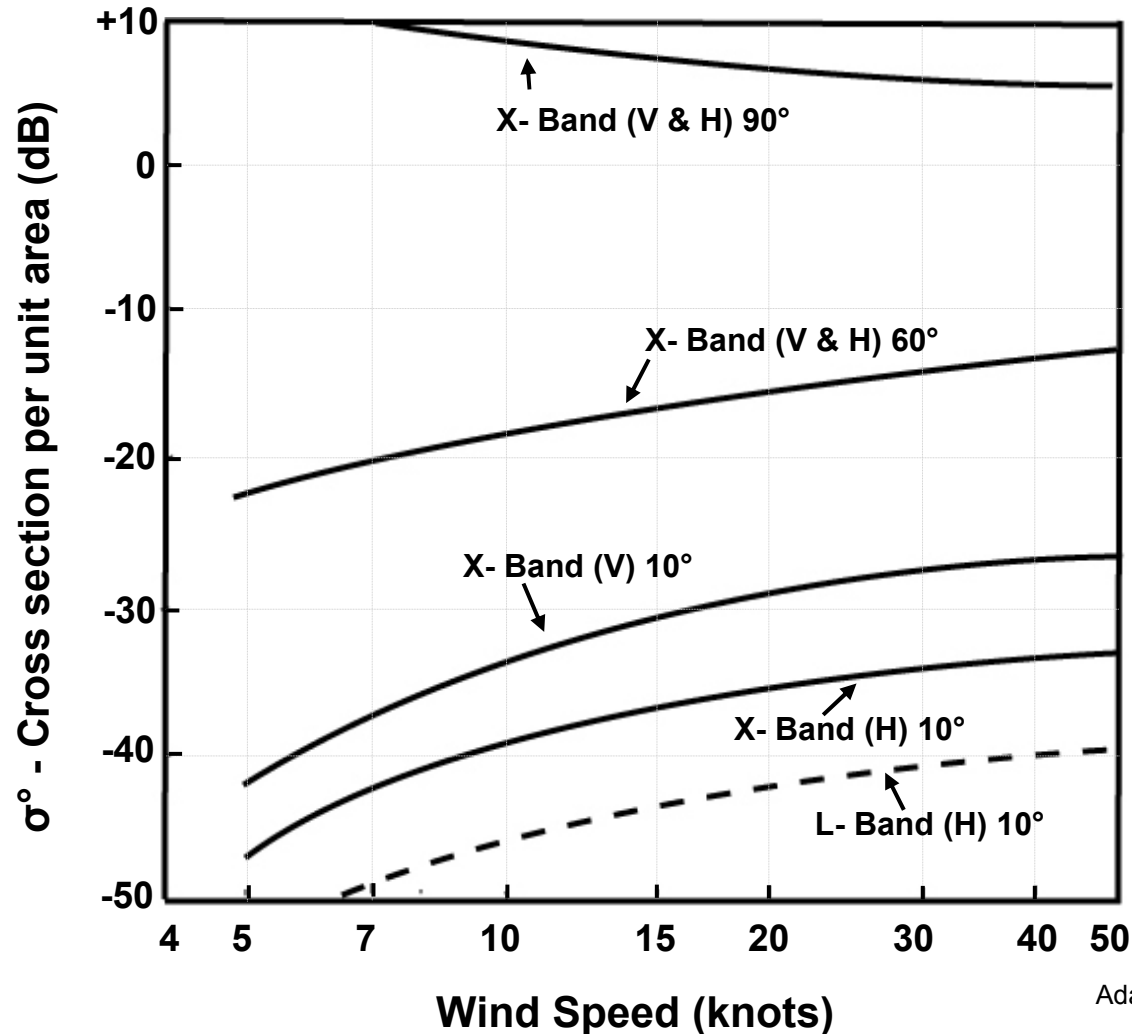

Adapted from Skolnik, Reference 6



Sea Clutter



Effects of the Wind and Waves

- σ° increases with increases in wind speed and wave height except at near-vertical incidence
- Wind speed and wave height, and wind direction and wave direction are not always highly correlated.
- At small grazing angles, σ° is highly sensitive to wave height
- At centimeter wavelengths, σ° is highly sensitive to wind speed at the small and intermediate grazing angles
- σ° is greatest looking into the wind and waves.
 - For small grazing angles, the upwind/downwind ratio is often as much as 5 dB and values of 10 dB have been reported

Adapted from Skolnik, Reference 6



More attributes of Sea Clutter



- **Sea clutter has a mean Doppler velocity and spread**
 - **Velocity of waves relative to radar (ship)**
Wind speed and direction
 - **Sea state**

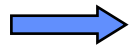

- **Sea “spikes”**
 - **Low grazing angles**
 - **Short radar pulse widths**



Sea Spikes

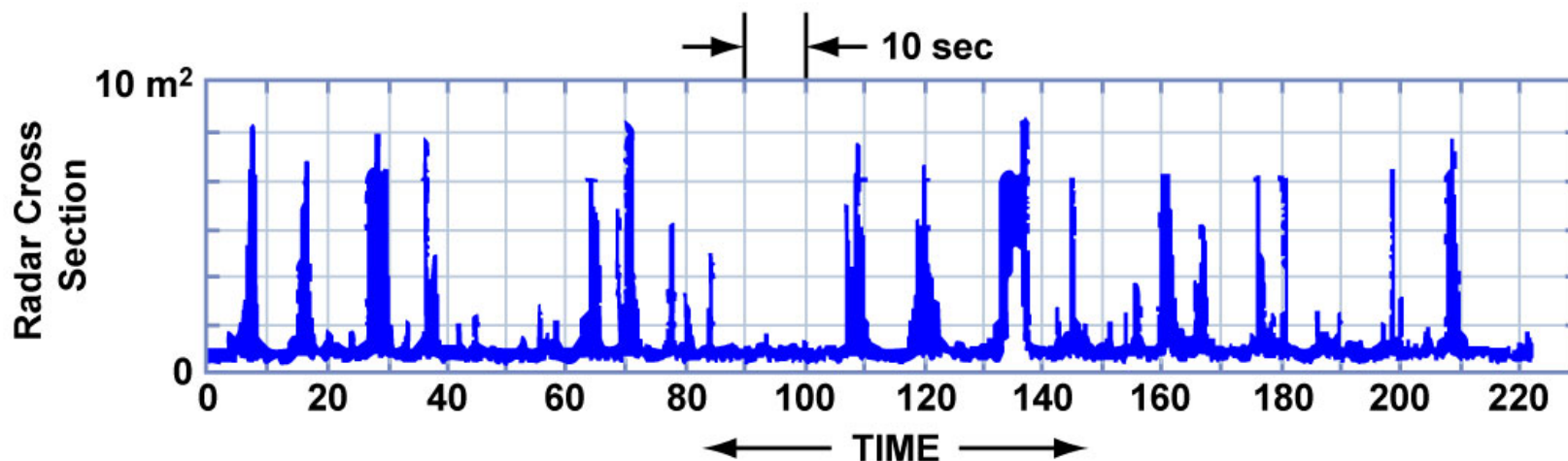

Figure by MIT OCW.

- Grazing angle 1.5 deg.
- Horizontal polarization

- **At low grazing angles, sharp sea clutter peaks, known as “sea spikes”, begin to appear**
- **These sea spikes can cause excessive false detections**

From Lewis and Olin, NRL



Sea Clutter Distributions (Low Grazing Angles)

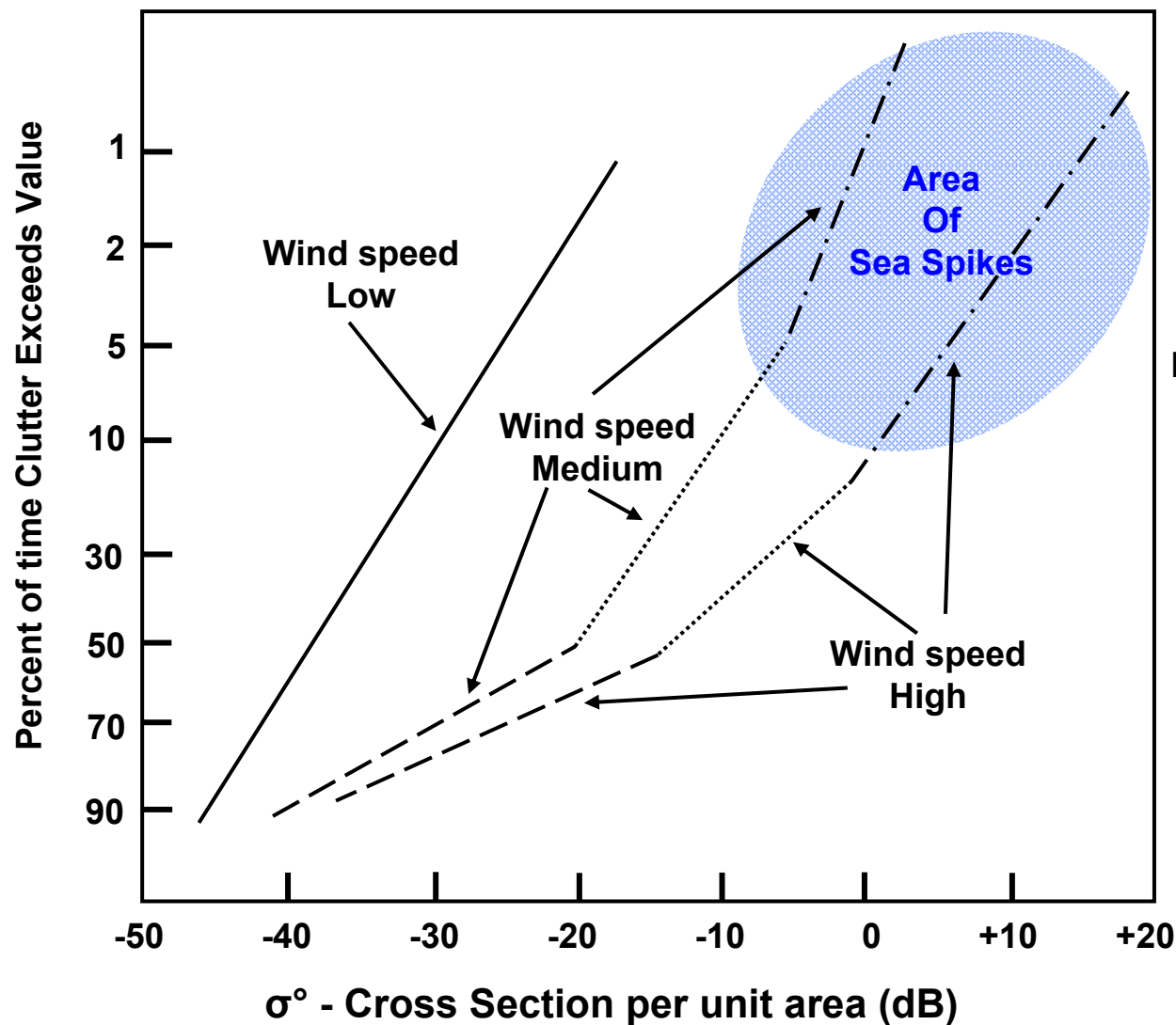
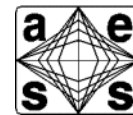

X-band Data
Grazing Angle 3°
Polarization - Horizontal

Adapted from Skolnik, reference 4



Sea Clutter Summary



- **Mean backscatter from sea is about 100 times less than that of ground**
 - **Amplitude of backscatter depends on Sea State and a number of other factors**

Radar wavelength, grazing angle, polarization, etc.
- **The platform motion of ship based radars and the motion of the sea due to wind give sea clutter a mean Doppler velocity**
- **Sea spikes can cause a false target problem**
 - **Occur at low grazing angles and moderate to high wind speeds**